

A

PANEL CUT OUT

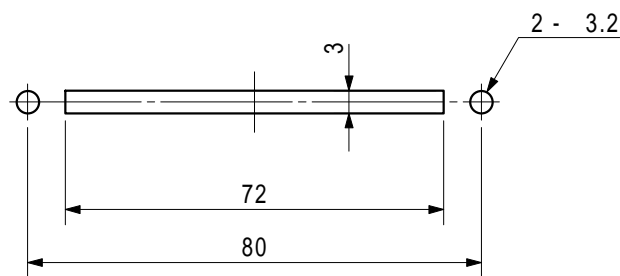

DIMENSIONS

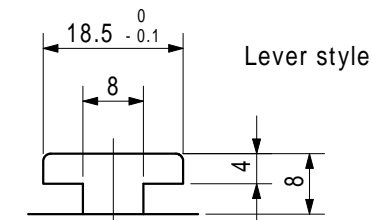
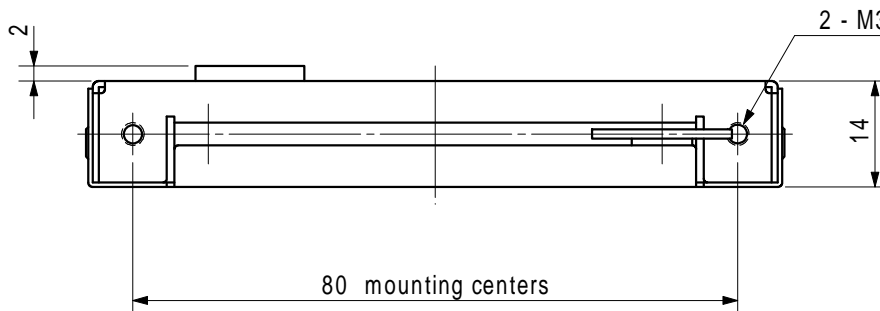

B

CIRCUIT DIAGRAMS

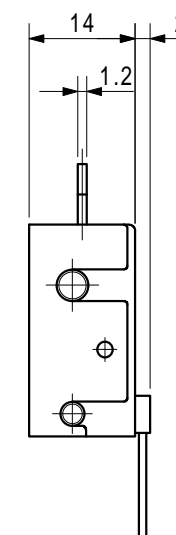
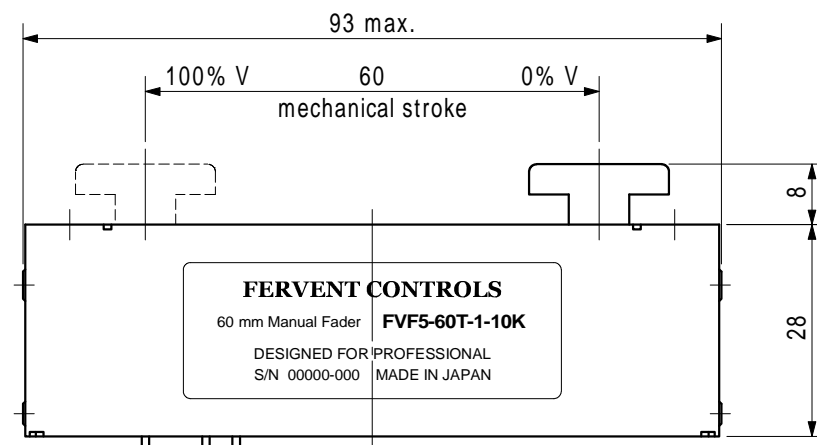
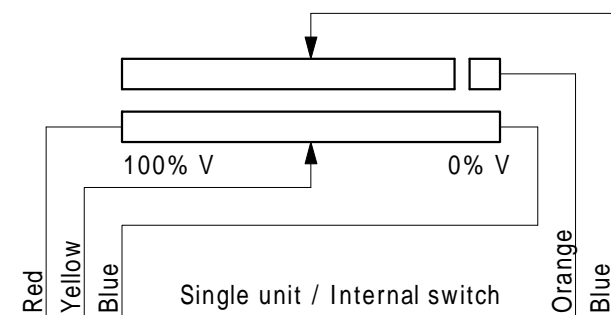
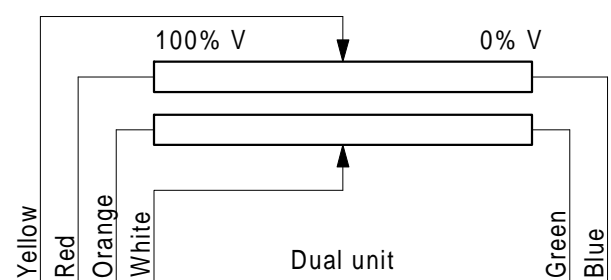
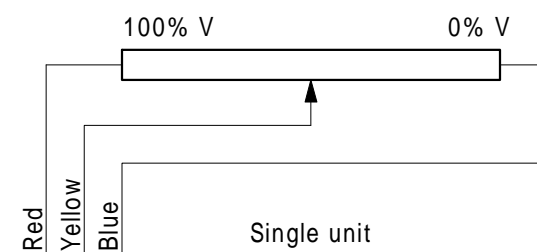

Mounting screw length

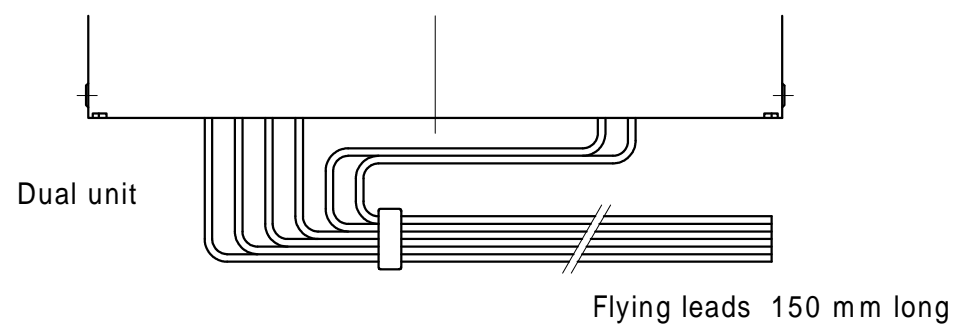
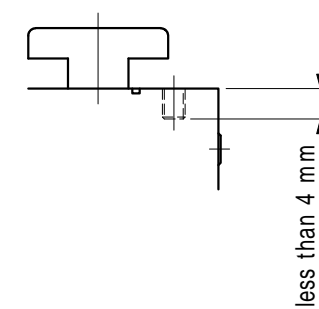

NUMBERING

FVF5 - 60 T - 1 - 10 K

- T Having sliding torque
- S Sooth feeling
- 1 Single unit
- 2 Dual unit
- 3 Single unit / Internal switch
- 10 Total Resistance 10k : Standard

E

REVISION	DATE	DESCRIPTION	DRAWN	CHECKED	APPROVED	MATERIAL	MODEL
4			12. Oct. 2019				FVF5-60
3			A.Ohtaki			SURFACE PREPARATION	TITLE
2							Manual Fader
1						SURFACE FINISHING	DOCUMENT NO.
SEET NO.		NOTE	SCALE		SURFACE FINISHING		DOCUMENT NO.
1 OF 1			1 / 1		FERVENT CONTROLS		