

PANEL CUT OUT

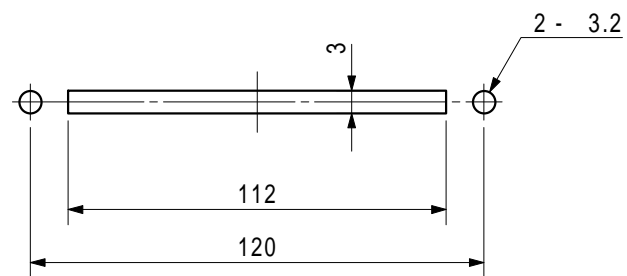

DIMENSIONS

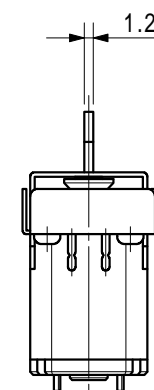
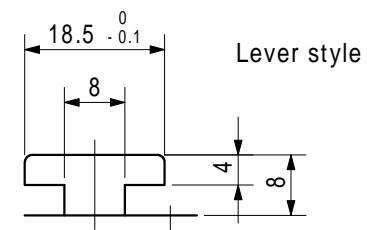
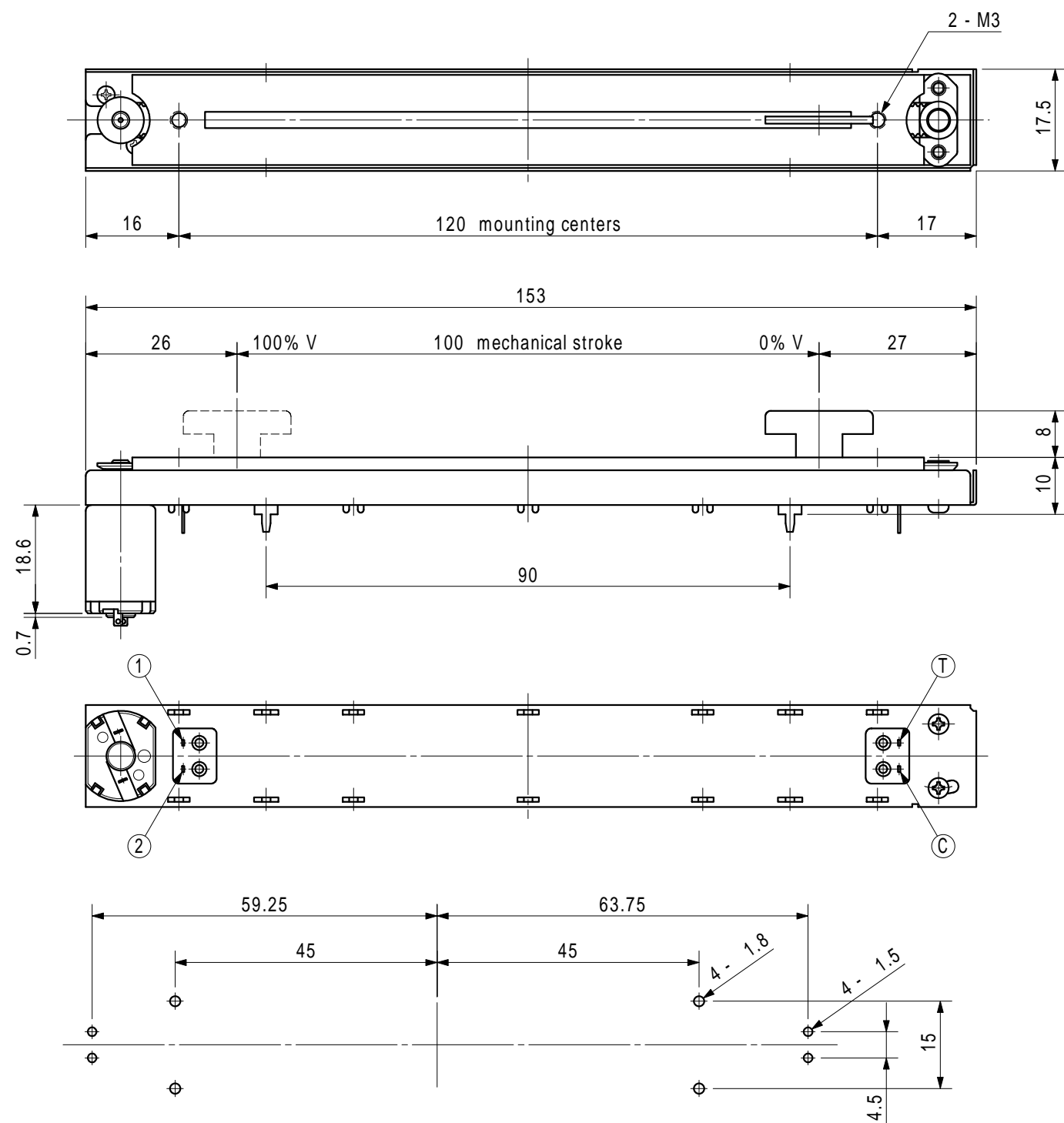

Mounting screw length

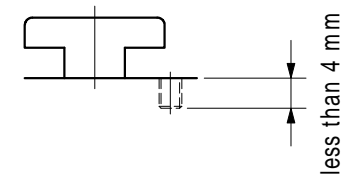

NUMBERING

FVMF3 - 100 - 10 K

10 Total Resistance 10k : Standard

CIRCUIT DIAGRAMS

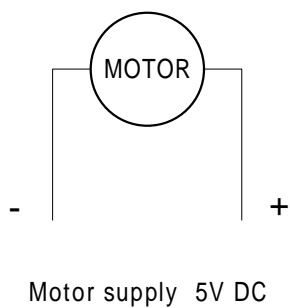
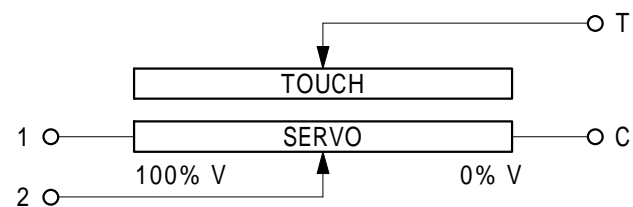

REVISION	DATE	DESCRIPTION	DRAWN	CHECKED	APPROVED	MATERIAL	MODEL
4			6. Oct. 2019				FVMF3-100
3			A.Ohtaki			SURFACE PREPARATION	TITLE
2						SURFACE FINISHING	Motorised Fader
1							DOCUMENT NO.
SEET NO.		NOTE	SCALE			DOCUMENT NO.	
1 OF 1			1 / 1			FERVENT CONTROLS	